

LM2936

Ultra-Low Quiescent Current LDO Voltage Regulator

General Description

The LM2936 ultra-low quiescent current regulator features low dropout voltage and low current in the standby mode. With less than 15 μA quiescent current at a 100 μA load, the LM2936 is ideally suited for automotive and other battery operated systems. The LM2936 retains all of the features that are common to low dropout regulators including a low dropout PNP pass device, short circuit protection, reverse battery protection, and thermal shutdown. The LM2936 has a 40V maximum operating voltage limit, a -40°C to $+125^{\circ}\text{C}$ operating temperature range, and $\pm 3\%$ output voltage tolerance over the entire output current, input voltage, and temperature range. The LM2936 is available in a TO-92 package, SO-8 and SOT-23 surface mount packages, and a TO-252 surface mount power package.

Features

- Ultra low quiescent current ($I_Q \leq 15 \mu\text{A}$ for $I_O = 100 \mu\text{A}$)
- Fixed 3.0V, 3.3V or 5.0V with 50 mA output
- $\pm 2\%$ Initial output tolerance
- $\pm 3\%$ Output tolerance over line, load, and temperature
- Dropout voltage typically 200 mV @ $I_O = 50 \text{ mA}$
- Reverse battery protection
- -50V reverse transient protection
- Internal short circuit current limit
- Internal thermal shutdown protection
- 40V operating voltage limit
- 60V operating voltage limit for LM2936HV
- Shutdown Pin available with LM2936BM package

Typical Application

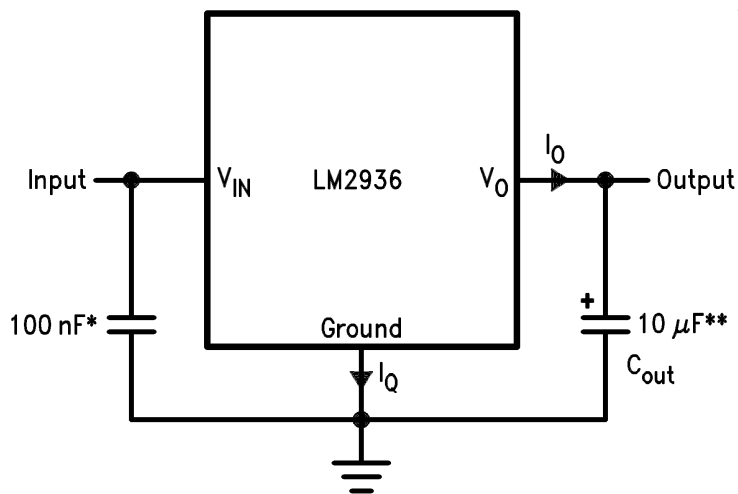

00975901

* Required if regulator is located more than 2" from power supply filter capacitor.

** Required for stability. See Electrical Characteristics for required values. Must be rated over intended operating temperature range. Effective series resistance (ESR) is critical, see curve. Locate capacitor as close as possible to the regulator output and ground pins. Capacitance may be increased without bound.

Connection Diagrams

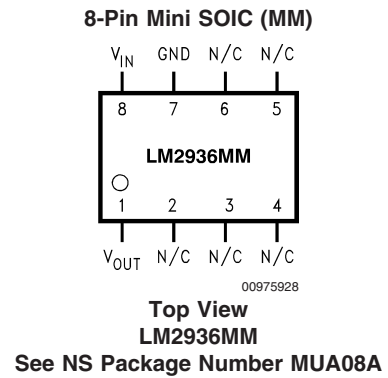
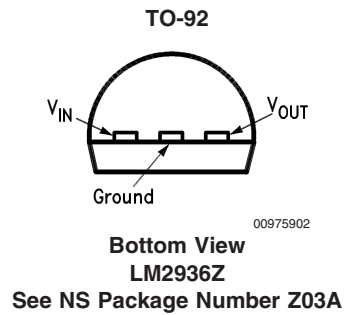
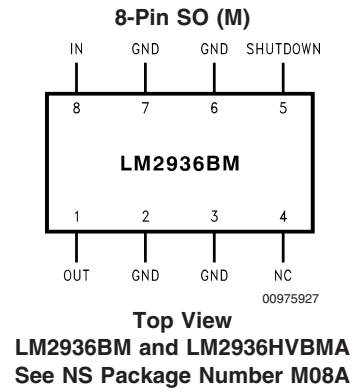
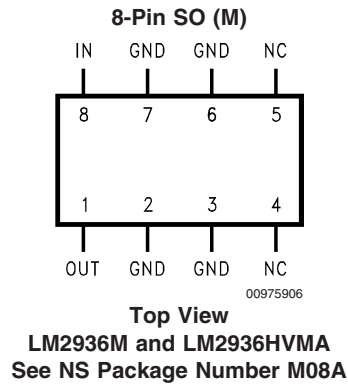
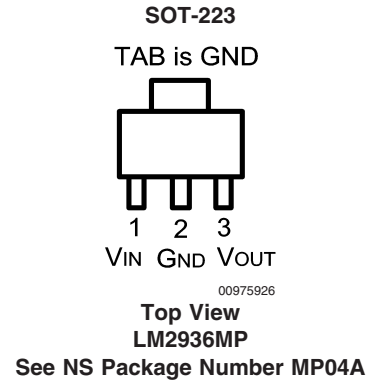
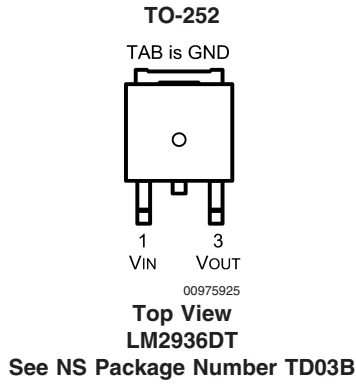

Ordering Information

Output Voltage	High Voltage	Shutdown Pin	Order	Package Type	Package Drawing	Transport Media
3.00V	-	Yes	LM2936BM-3.0	8-Lead SOIC	M08A	Rail
	-	Yes	LM2936BMX-3.0	8-Lead SOIC	M08A	Tape/Reel
	-	-	LM2936DT-3.0	TO-252	TD03B	Rail
	-	-	LM2936DTX-3.0	TO-252	TD03B	Tape/Reel
	Yes	Yes	LM2936HVBMA-3.0	8-Lead SOIC	M08A	Rail
	Yes	Yes	LM2936HVBMAX3.0	8-Lead SOIC	M08A	Tape/Reel
	-	-	LM2936M-3.0	8-Lead SOIC	M08A	Rail
	-	-	LM2936MX-3.0	8-Lead SOIC	M08A	Tape/Reel
	-	-	LM2936MP-3.0	SOT-223	MP04A	Tape/Reel
	-	-	LM2936MPX-3.0	SOT-223	MP04A	Tape/Reel
	-	-	LM2936MM-3.0	8-Lead Mini SOIC	MUA08A	Rail
	-	-	LM2936MMX-3.0	8-Lead Mini SOIC	MUA08A	Tape/Reel
	-	-	LM2936Z-3.0	TO-92	Z03A	Box
3.30V	-	Yes	LM2936BM-3.3	8-Lead SOIC	M08A	Rail
	-	Yes	LM2936BMX-3.3	8-Lead SOIC	M08A	Tape/Reel
	-	-	LM2936DT-3.3	TO-252	TD03B	Rail
	-	-	LM2936DTX-3.3	TO-252	TD03B	Tape/Reel
	Yes	Yes	LM2936HVBMA-3.3	8-Lead SOIC	M08A	Rail
	Yes	Yes	LM2936HVBMAX3.3	8-Lead SOIC	M08A	Tape/Reel
	-	-	LM2936M-3.3	8-Lead SOIC	M08A	Rail
	-	-	LM2936MX-3.3	8-Lead SOIC	M08A	Tape/Reel
	-	-	LM2936MP-3.3	SOT-223	MP04A	Tape/Reel
	-	-	LM2936MPX-3.3	SOT-223	MP04A	Tape/Reel
	-	-	LM2936MM-3.3	8-Lead Mini- SOIC	MUA08A	Rail
	-	-	LM2936MMX-3.3	8-Lead Mini- SOIC	MUA08A	Tape/Reel
	-	-	LM2936Z-3.3	TO-92	Z03A	Box
5.00V	-	Yes	LM2936BM-5.0	8-Lead SOIC	M08A	Rail
	-	Yes	LM2936BMX-5.0	8-Lead SOIC	M08A	Tape/Reel
	-	-	LM2936DT-5.0	TO-252	TD03B	Rail
	-	-	LM2936DTX-5.0	TO-252	TD03B	Tape/Reel
	Yes	Yes	LM2936HVBMA-5.0	8-Lead SOIC	M08A	Rail
	Yes	Yes	LM2936HVBMAX5.0	8-Lead SOIC	M08A	Tape/Reel
	Yes	-	LM2936HVMA-5.0	8-Lead SOIC	M08A	Rail
	Yes	-	LM2936HVMAX-5.0	8-Lead SOIC	M08A	Tape/Reel
	-	-	LM2936M-5.0	8-Lead SOIC	M08A	Rail
	-	-	LM2936MX-5.0	8-Lead SOIC	M08A	Tape/Reel
	-	-	LM2936MP-5.0	SOT-223	MP04A	Tape/Reel
	-	-	LM2936MPX-5.0	SOT-223	MP04A	Tape/Reel
	-	-	LM2936MM-5.0	8-Lead Mini-SOIC	MUA08A	Rail
	-	-	LM2936MMX-5.0	8-Lead Mini-SOIC	MUA08A	Tape/Reel
-	-	LM2936Z-5.0	TO-92	Z03A	Box	

Absolute Maximum Ratings (Note 1)

If Military/Aerospace specified devices are required, please contact the National Semiconductor Sales Office/Distributors for availability and specifications.

Input Voltage (Survival)	+60V, -50V
ESD Susceptibility (Note 2)	2000V
Power Dissipation (Note 3)	Internally limited
Junction Temperature (T_{Jmax})	150°C
Storage Temperature Range	-65°C to +150°C
Lead Temperature (Soldering, 10 sec.)	260°C

Operating Ratings

Operating Temperature Range	-40°C to +125°C
Maximum Operating Input Voltage - LM2936	+40V
Maximum Operating Input Voltage - LM2936HV only	+60V
Maximum Shutdown Pin Voltage - LM2936BM only	0V to 40V
TO-92 (Z03A) θ_{JA}	195°C/W
MSO-8 (MUA08A) θ_{JA}	200°C/W
SO-8 (M08A) θ_{JA}	140°C/W
SO-8 (M08A) θ_{JC}	45°C/W
TO-252 (TD03B) θ_{JA}	136°C/W
TO-252 (TD03B) θ_{JC}	6°C/W
SOT-223 (MP04A) θ_{JA}	149°C/W
SOT-223 (MP04A) θ_{JC}	36°C/W

Electrical Characteristics for LM2936-3.0

$V_{IN} = 14V$, $I_O = 10\text{ mA}$, $T_J = 25^\circ\text{C}$, unless otherwise specified. **Boldface** limits apply over entire operating temperature range

Parameter	Conditions	Min (Note 5)	Typical (Note 4)	Max (Note 5)	Units
LM2936HV-3.0 Only					
Output Voltage	$5.5V \leq V_{IN} \leq 48V$, $100\ \mu A \leq I_O \leq 50\text{ mA}$ (Note 6)	2.910	3.000	3.090	V
Line Regulation	$6V \leq V_{IN} \leq 60V$, $I_O = 1\text{ mA}$		10	30	mV
All LM2936-3.0					
Output Voltage	$4.0V \leq V_{IN} \leq 26V$, $100\ \mu A \leq I_O \leq 50\text{ mA}$ (Note 6)	2.940	3.000	3.060	V
Quiescent Current	$I_O = 100\ \mu A$, $8V \leq V_{IN} \leq 24V$		15	20	μA
	$I_O = 10\text{ mA}$, $8V \leq V_{IN} \leq 24V$		0.20	0.50	mA
	$I_O = 50\text{ mA}$, $8V \leq V_{IN} \leq 24V$		1.5	2.5	mA
Line Regulation	$9V \leq V_{IN} \leq 16V$		5	10	mV
	$6V \leq V_{IN} \leq 40V$, $I_O = 1\text{ mA}$		10	30	
Load Regulation	$100\ \mu A \leq I_O \leq 5\text{ mA}$		10	30	mV
	$5\text{ mA} \leq I_O \leq 50\text{ mA}$		10	30	
Dropout Voltage	$I_O = 100\ \mu A$		0.05	0.10	V
	$I_O = 50\text{ mA}$		0.20	0.40	V
Short Circuit Current	$V_O = 0V$	65	120	250	mA
Output Impedance	$I_O = 30\text{ mAdc}$ and 10 mArms , $f = 1000\text{ Hz}$		450		$m\Omega$
Output Noise Voltage	10 Hz–100 kHz		500		μV
Long Term Stability			20		mV/1000 Hr
Ripple Rejection	$V_{ripple} = 1V_{rms}$, $f_{ripple} = 120\text{ Hz}$	-40	-60		dB
Reverse Polarity	$R_L = 500\Omega$, $T = 1\text{ ms}$	-50	-80		V
Transient Input Voltage					
Output Voltage with Reverse Polarity Input	$V_{IN} = -15V$, $R_L = 500\Omega$		0.00	-0.30	V
Maximum Line Transient	$R_L = 500\Omega$, $V_O \leq 3.30V$, $T = 40\text{ ms}$	60			V

Electrical Characteristics for LM2936–3.0 (Continued)
 $V_{IN} = 14V$, $I_O = 10\text{ mA}$, $T_J = 25^\circ\text{C}$, unless otherwise specified. **Boldface** limits apply over entire operating temperature range

Parameter	Conditions	Min (Note 5)	Typical (Note 4)	Max (Note 5)	Units
Output Bypass Capacitance (C_{OUT}) ESR	$C_{OUT} = 22\mu\text{F}$ $0.1\text{mA} \leq I_{OUT} \leq 50\text{mA}$	0.3		8	Ω
Shutdown Input – LM2936BM–3.0 Only					
Output Voltage, V_{OUT}	Output Off, $V_{SD}=2.4V$, $R_{LOAD} = 500\Omega$		0	0.010	V
Shutdown High Threshold Voltage, V_{IH}	Output Off, $R_{LOAD} = 500\Omega$	2.00	1.1		V
Shutdown Low Threshold Voltage, V_{IL}	Output On, $R_{LOAD} = 500\Omega$		1.1	0.60	V
Shutdown High Current, I_{IH}	Output Off, $V_{SD} = 2.4V$, $R_{LOAD} = 500\Omega$		12		μA
Quiescent Current	Output Off, $V_{SD} = 2.4V$, $R_{LOAD} = 500\Omega$ Includes I_{IH} Current		30		μA

Electrical Characteristics for LM2936–3.3
 $V_{IN} = 14V$, $I_O = 10\text{ mA}$, $T_J = 25^\circ\text{C}$, unless otherwise specified. **Boldface** limits apply over entire operating temperature range

Parameter	Conditions	Min (Note 5)	Typical (Note 4)	Max (Note 5)	Units
LM2936HV–3.3 Only					
Output Voltage	$5.5V \leq V_{IN} \leq 48V$, $100\mu\text{A} \leq I_O \leq 50\text{ mA}$ (Note 6)	3.201	3.300	3.399	V
Line Regulation	$6V \leq V_{IN} \leq 60V$, $I_O = 1\text{mA}$		10	30	mV
All LM2936–3.3					
Output Voltage	$4.0V \leq V_{IN} \leq 26V$, $100\mu\text{A} \leq I_O \leq 50\text{ mA}$ (Note 6)	3.234	3.300	3.366	V
Quiescent Current	$I_O = 100\mu\text{A}$, $8V \leq V_{IN} \leq 24V$		15	20	μA
	$I_O = 10\text{ mA}$, $8V \leq V_{IN} \leq 24V$		0.20	0.50	mA
	$I_O = 50\text{ mA}$, $8V \leq V_{IN} \leq 24V$		1.5	2.5	mA
Line Regulation	$9V \leq V_{IN} \leq 16V$		5	10	mV
	$6V \leq V_{IN} \leq 40V$, $I_O = 1\text{ mA}$		10	30	mV
Load Regulation	$100\mu\text{A} \leq I_O \leq 5\text{ mA}$		10	30	mV
	$5\text{ mA} \leq I_O \leq 50\text{ mA}$		10	30	mV
Dropout Voltage	$I_O = 100\mu\text{A}$		0.05	0.10	V
	$I_O = 50\text{ mA}$		0.20	0.40	V
Short Circuit Current	$V_O = 0V$	65	120	250	mA
Output Impedance	$I_O = 30\text{ mAdc}$ and 10 mArms , $f = 1000\text{ Hz}$		450		$\text{m}\Omega$
Output Noise Voltage	10 Hz–100 kHz		500		μV
Long Term Stability			20		mV/1000 Hr
Ripple Rejection	$V_{\text{ripple}} = 1V_{\text{rms}}$, $f_{\text{ripple}} = 120\text{ Hz}$	-40	-60		dB
Reverse Polarity Transient Input Voltage	$R_L = 500\Omega$, $T = 1\text{ ms}$	-50	-80		V
Output Voltage with Reverse Polarity Input	$V_{IN} = -15V$, $R_L = 500\Omega$		0.00	-0.30	V
Maximum Line Transient	$R_L = 500\Omega$, $V_O \leq 3.63V$, $T = 40\text{ms}$	60			V

Electrical Characteristics for LM2936–3.3 (Continued)
 $V_{IN} = 14V$, $I_O = 10\text{ mA}$, $T_J = 25^\circ\text{C}$, unless otherwise specified. **Boldface** limits apply over entire operating temperature range

Parameter	Conditions	Min (Note 5)	Typical (Note 4)	Max (Note 5)	Units
Output Bypass Capacitance (C_{OUT}) ESR	$C_{OUT} = 22\mu\text{F}$ $0.1\text{mA} \leq I_{OUT} \leq 50\text{mA}$	0.3		8	Ω
Shutdown Input – LM2936BM–3.3 Only					
Output Voltage, V_{OUT}	Output Off, $V_{SD}=2.4V$, $R_{LOAD} = 500\Omega$		0	0.010	V
Shutdown High Threshold Voltage, V_{IH}	Output Off, $R_{LOAD} = 500\Omega$	2.00	1.1		V
Shutdown Low Threshold Voltage, V_{IL}	Output On, $R_{LOAD} = 500\Omega$		1.1	0.60	V
Shutdown High Current, I_{IH}	Output Off, $V_{SD} = 2.4V$, $R_{LOAD} = 500\Omega$		12		μA
Quiescent Current	Output Off, $V_{SD} = 2.4V$, $R_{LOAD} = 500\Omega$ Includes I_{IH} Current		30		μA

Electrical Characteristics for LM2936–5.0
 $V_{IN} = 14V$, $I_O = 10\text{ mA}$, $T_J = 25^\circ\text{C}$, unless otherwise specified. **Boldface** limits apply over entire operating temperature range

Parameter	Conditions	Min (Note 5)	Typical (Note 4)	Max (Note 5)	Units
LM2936HV–5.0 Only					
Output Voltage	$5.5V \leq V_{IN} \leq 48V$, $100\mu\text{A} \leq I_O \leq 50\text{ mA}$ (Note 6)	4.85	5.00	5.15	V
Line Regulation	$6V \leq V_{IN} \leq 60V$, $I_O = 1\text{ mA}$		15	35	mV
All LM2936–5.0					
Output Voltage	$5.5V \leq V_{IN} \leq 26V$, $100\mu\text{A} \leq I_O \leq 50\text{ mA}$ (Note 6)	4.85	5.00	5.10	V
Quiescent Current	$I_O = 100\mu\text{A}$, $8V \leq V_{IN} \leq 24V$		9	15	μA
	$I_O = 10\text{ mA}$, $8V \leq V_{IN} \leq 24V$		0.20	0.50	mA
	$I_O = 50\text{ mA}$, $8V \leq V_{IN} \leq 24V$		1.5	2.5	mA
Line Regulation	$9V \leq V_{IN} \leq 16V$		5	10	mV
	$6V \leq V_{IN} \leq 40V$, $I_O = 1\text{ mA}$		10	30	mV
Load Regulation	$100\mu\text{A} \leq I_O \leq 5\text{ mA}$		10	30	mV
	$5\text{ mA} \leq I_O \leq 50\text{ mA}$		10	30	mV
Dropout Voltage	$I_O = 100\mu\text{A}$		0.05	0.10	V
	$I_O = 50\text{ mA}$		0.20	0.40	V
Short Circuit Current	$V_O = 0V$	65	120	250	mA
Output Impedance	$I_O = 30\text{ mAdc}$ and 10 mArms , $f = 1000\text{ Hz}$		450		$\text{m}\Omega$
Output Noise Voltage	10 Hz–100 kHz		500		μV
Long Term Stability			20		mV/1000 Hr
Ripple Rejection	$V_{\text{ripple}} = 1V_{\text{rms}}$, $f_{\text{ripple}} = 120\text{ Hz}$	-40	-60		dB
Reverse Polarity Transient Input Voltage	$R_L = 500\Omega$, $T = 1\text{ ms}$	-50	-80		V
Output Voltage with Reverse Polarity Input	$V_{IN} = -15V$, $R_L = 500\Omega$		0.00	-0.30	V
Maximum Line Transient	$R_L = 500\Omega$, $V_O \leq 5.5V$, $T = 40\text{ms}$	60			V

Electrical Characteristics for LM2936–5.0 (Continued)

$V_{IN} = 14V$, $I_O = 10\text{ mA}$, $T_J = 25^\circ\text{C}$, unless otherwise specified. **Boldface** limits apply over entire operating temperature range

Parameter	Conditions	Min (Note 5)	Typical (Note 4)	Max (Note 5)	Units
Output Bypass Capacitance (C_{OUT}) ESR	$C_{OUT} = 10\mu\text{F}$ $0.1\text{mA} \leq I_{OUT} \leq 50\text{mA}$	0.3		8	Ω
Shutdown Input – LM2936BM–5.0 Only					
Output Voltage, V_{OUT}	Output Off, $V_{SD}=2.4V$, $R_{LOAD} = 500\Omega$		0	0.010	V
Shutdown High Threshold Voltage, V_{IH}	Output Off, $R_{LOAD} = 500\Omega$	2.00	1.1		V
Shutdown Low Threshold Voltage, V_{IL}	Output On, $R_{LOAD} = 500\Omega$		1.1	0.60	V
Shutdown High Current, I_{IH}	Output Off, $V_{SD} = 2.4V$, $R_{LOAD} = 500\Omega$		12		μA
Quiescent Current	Output Off, $V_{SD} = 2.4V$, $R_{LOAD} = 500\Omega$ Includes I_{IH} Current		30		μA

Note 1: Absolute Maximum Ratings indicate limits beyond which damage to the device may occur. DC and AC electrical specifications do not apply when operating the device beyond its specified operating ratings.

Note 2: Human body model, 100 pF discharge through a 1.5 k Ω resistor.

Note 3: The maximum power dissipation is a function of T_{Jmax} , θ_{JA} , and T_A . The maximum allowable power dissipation at any ambient temperature is $P_D = (T_{Jmax} - T_A)/\theta_{JA}$. If this dissipation is exceeded, the die temperature will rise above 150°C and the LM2936 will go into thermal shutdown.

Note 4: Typical values are at 25°C (unless otherwise specified) and represent the most likely parametric norm.

Note 5: Datasheet min/max specification limits are guaranteed by design, test, or statistical analysis.

Note 6: To ensure constant junction temperature, pulse testing is used.

Typical Performance Characteristics

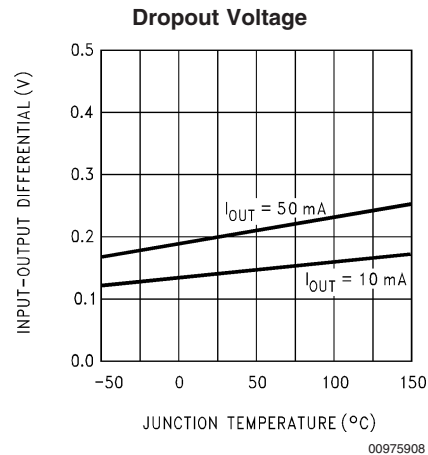
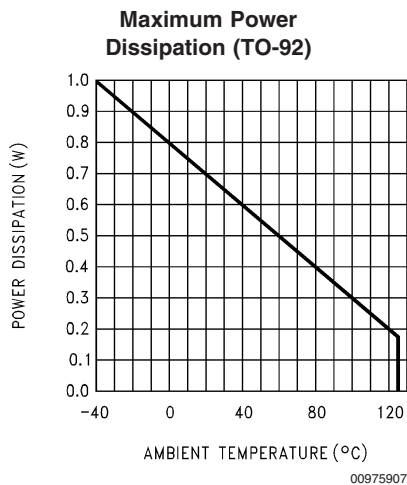

Typical Performance Characteristics (Continued)

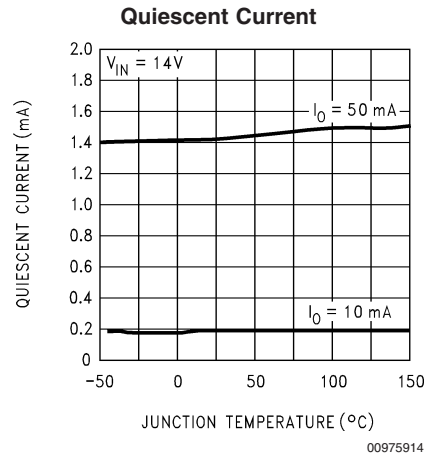
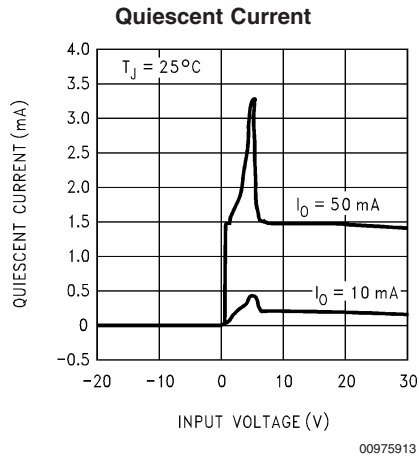
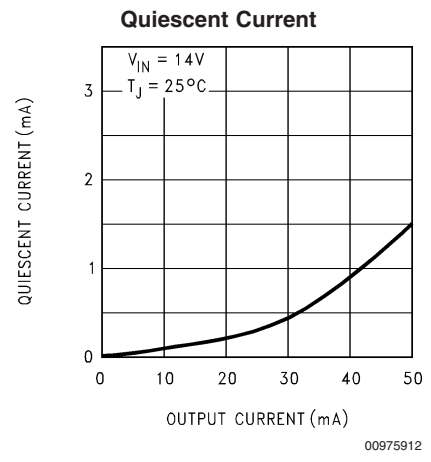
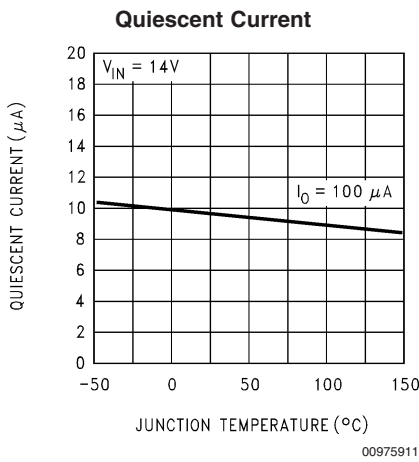
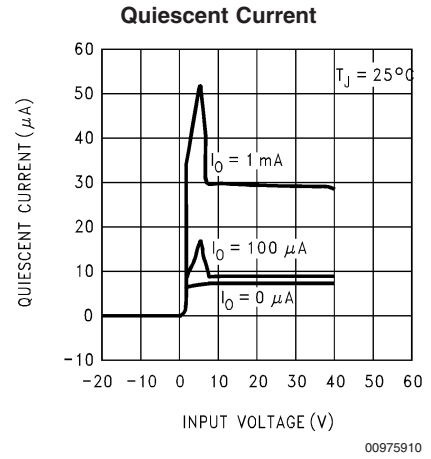
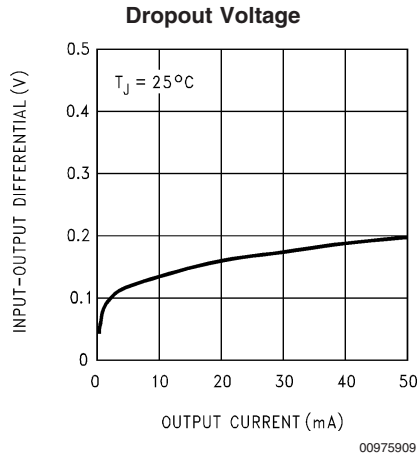

Typical Performance Characteristics (Continued)

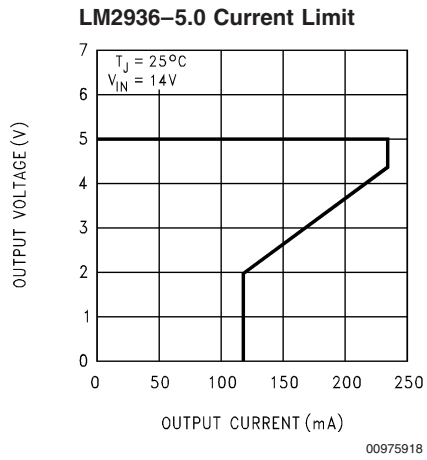
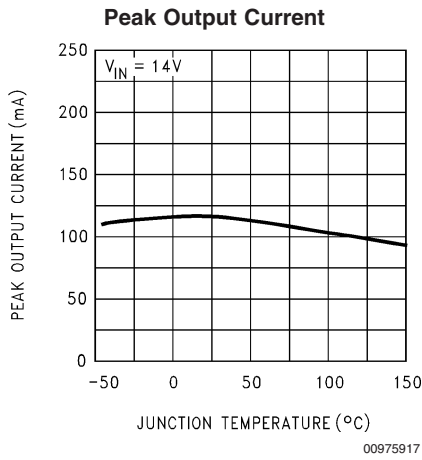
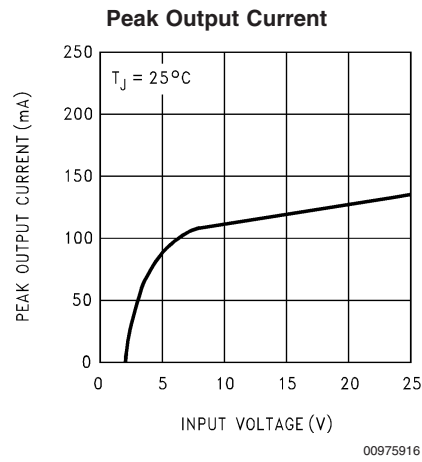
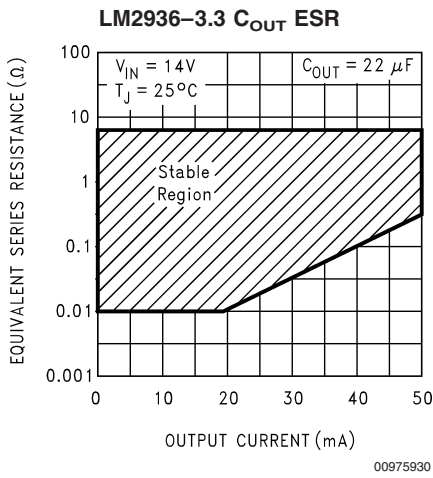
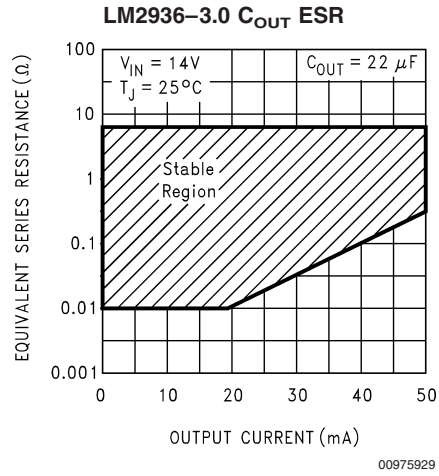
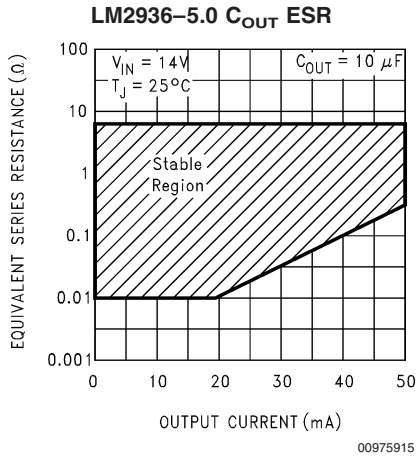

Typical Performance Characteristics (Continued)

LM2936-5.0 Line Transient Response

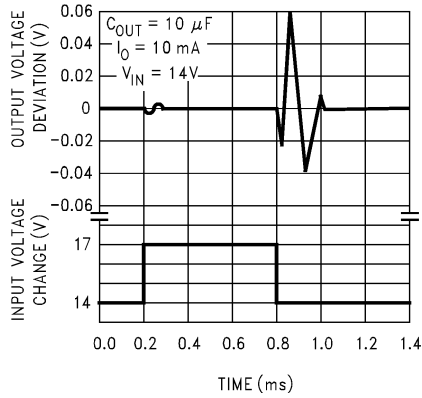

00975919

LM2936-5.0 Output at Voltage Extremes

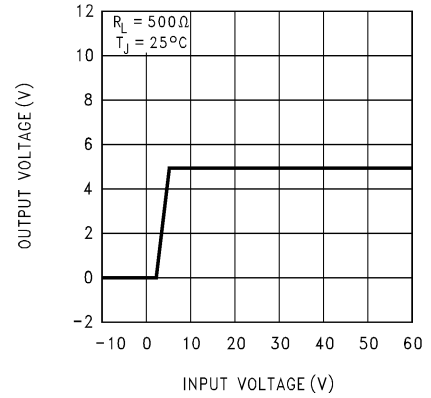

00975920

LM2936-5.0 Ripple Rejection

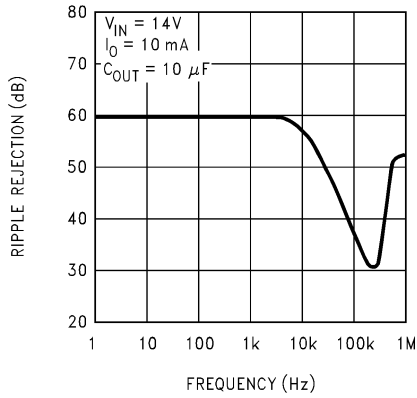

00975921

LM2936-5.0 Load Transient Response

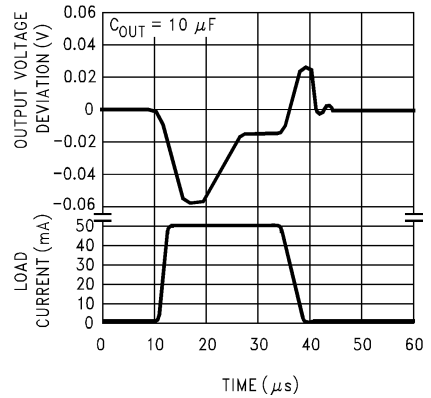

00975922

LM2936-5.0 Low Voltage Behavior

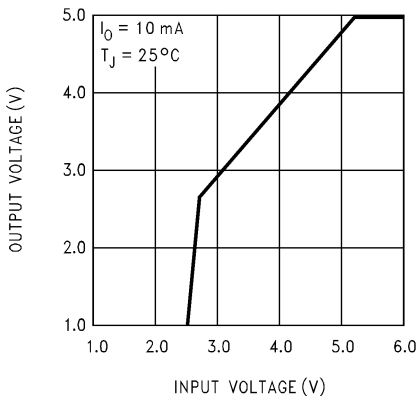

00975923

LM2936-5.0 Output Impedance

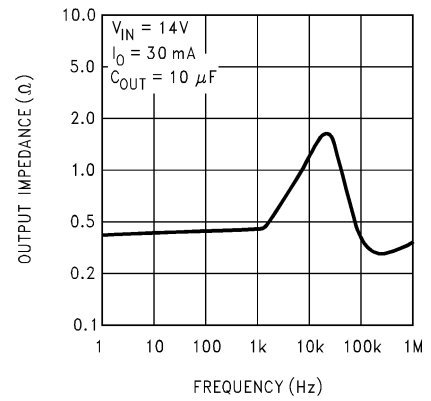

00975924

Applications Information

Unlike other PNP low dropout regulators, the LM2936 remains fully operational to 40V. Owing to power dissipation characteristics of the available packages, full output current cannot be guaranteed for all combinations of ambient temperature and input voltage. As an example, consider an LM2936Z–5.0 operating at 25°C ambient. Using the formula for maximum allowable power dissipation given in (Note 3), we find that $P_{Dmax} = 641 \text{ mW}$ at 25°C. Including the small contribution of the quiescent current to total power dissipation the maximum input voltage (while still delivering 50 mA output current) is 17.3V. The LM2936Z–5.0 will go into thermal shutdown if it attempts to deliver full output current with an input voltage of more than 17.3V. Similarly, at 40V input and 25°C ambient the LM2936Z–5.0 can deliver 18 mA maximum.

Under conditions of higher ambient temperatures, the voltage and current calculated in the previous examples will drop. For instance, at the maximum ambient of 125°C the LM2936Z–5.0 can only dissipate 128 mW, limiting the input voltage to 7.34V for a 50 mA load, or 3.5 mA output current for a 40V input.

The junction to ambient thermal resistance θ_{JA} rating has two distinct components: the junction to case thermal resistance rating θ_{JC} ; and the case to ambient thermal resistance rating θ_{CA} . The relationship is defined as: $\theta_{JA} = \theta_{JC} + \theta_{CA}$.

For the SO-8 and TO-252 surface mount packages the θ_{JA} rating can be improved by using the copper mounting pads on the printed circuit board as a thermal conductive path to extract heat from the package.

On the SO-8 package the four ground pins are thermally connected to the backside of the die. Adding approximately 0.04 square inches of 2 oz. copper pad area to these four pins will improve the θ_{JA} rating to approximately 110°C/W. If this extra pad area is placed directly beneath the package there should not be any impact on board density.

On the TO-252 package the ground tab is thermally connected to the backside of the die. Adding 1 square inch of 2 oz. copper pad area directly under the ground tab will improve the θ_{JA} rating to approximately 50°C/W.

While the LM2936 has an internally set thermal shutdown point of typically 160°C, this is intended as a safety feature only. Continuous operation near the thermal shutdown temperature should be avoided as it may have a negative affect on the life of the device.

While the LM2936 maintains regulation to 60V, it will not withstand a short circuit above 40V because of safe operating area limitations in the internal PNP pass device. Above 60V the LM2936 will break down with catastrophic effects on the regulator and possibly the load as well. Do not use this device in a design where the input operating voltage may exceed 40V, or where transients are likely to exceed 60V.

SHUTDOWN PIN

The LM2936BM has a pin for shutting down the regulator output. Applying a Logic Level High (>2.0V) to the Shutdown pin will cause the output to turn off. Leaving the Shutdown pin open, connecting it to Ground, or applying a Logic Level Low (<0.6V) will allow the regulator output to turn on.

Equivalent Schematic Diagram

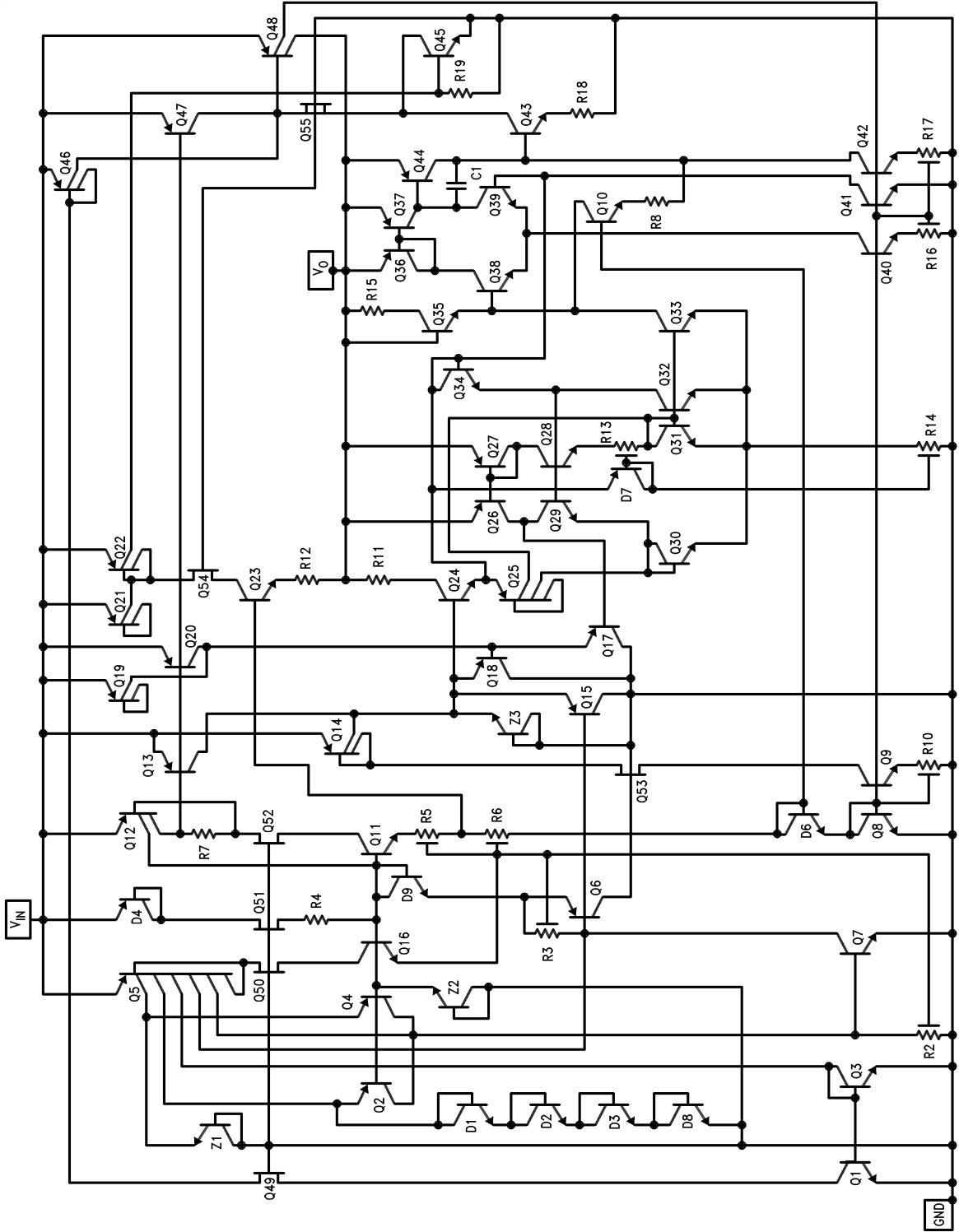

00975905

Physical Dimensions inches (millimeters) unless otherwise noted

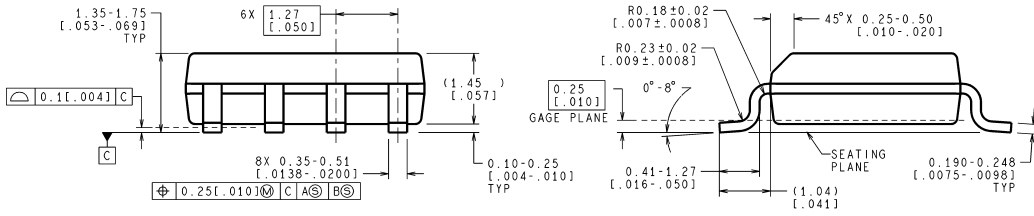
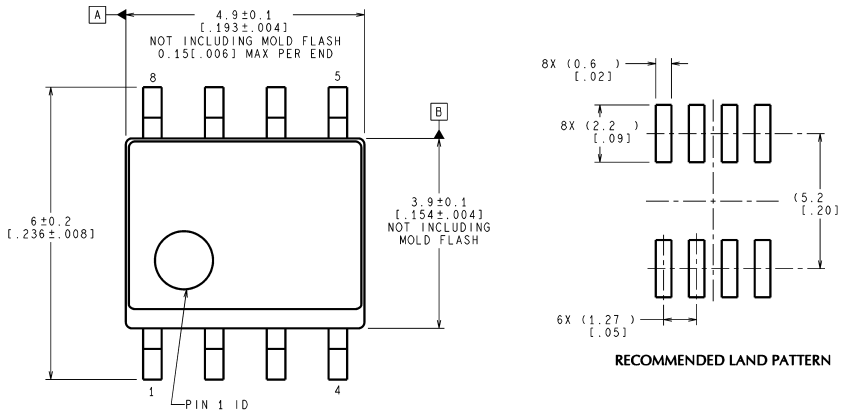

CONTROLLING DIMENSION IS MILLIMETER
 VALUES IN [] ARE INCHES
 DIMENSIONS IN () FOR REFERENCE ONLY

M08A (Rev L)

**8-Lead Small Outline Molded Package (M)
 NS Package Number M08A**

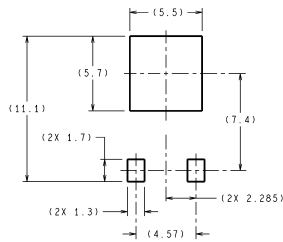

DIMENSIONS ARE IN MILLIMETERS

LAND PATTERN RECOMMENDATION

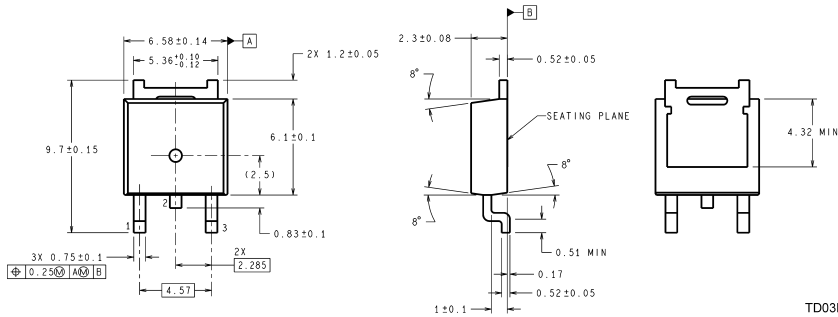

TD03B (Rev C)

**TO-252 Package (DT)
 NS Package Number TD03B**

Physical Dimensions inches (millimeters) unless otherwise noted (Continued)

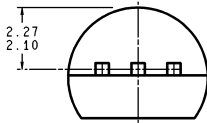
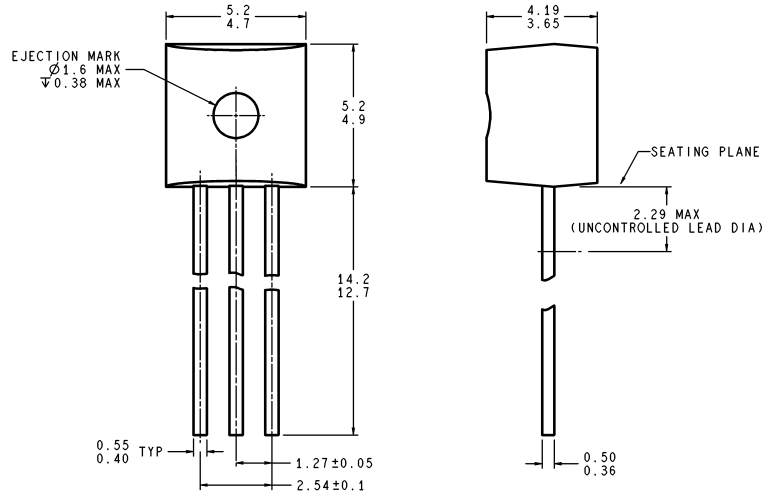

DIMENSIONS ARE IN MILLIMETERS

Z03A (Rev 6)

**3-Lead TO-92 Plastic Package (Z)
NS Package Number Z03A**

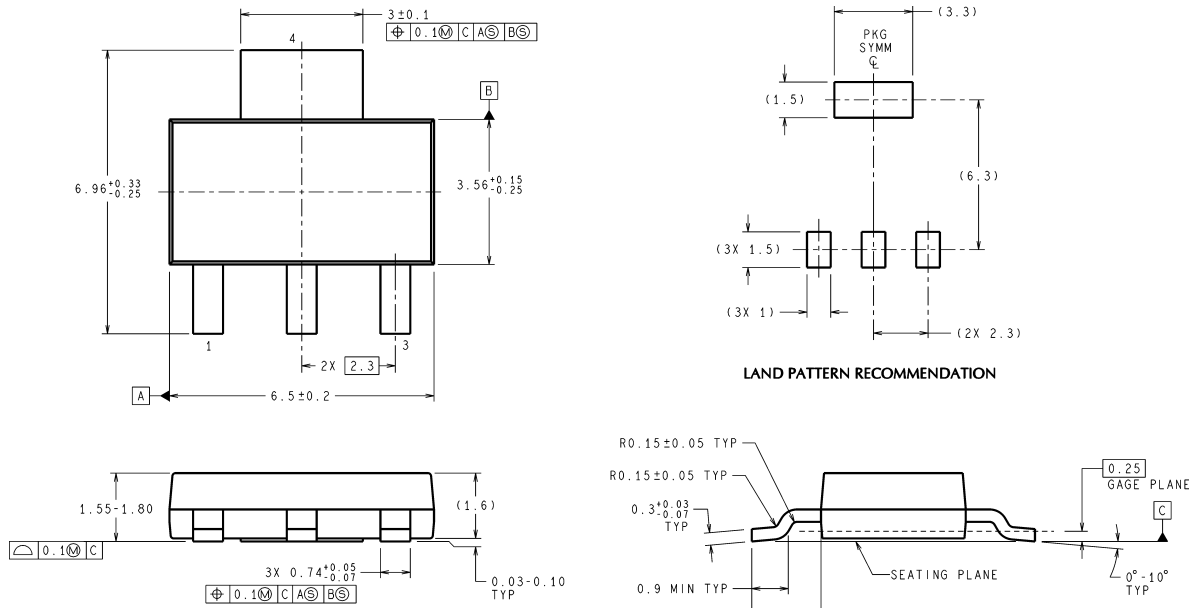

DIMENSIONS ARE IN MILLIMETERS

MP04A (Rev B)

**SOT-223 Package (MP)
NS Package Number MP04A**

Physical Dimensions inches (millimeters) unless otherwise noted (Continued)

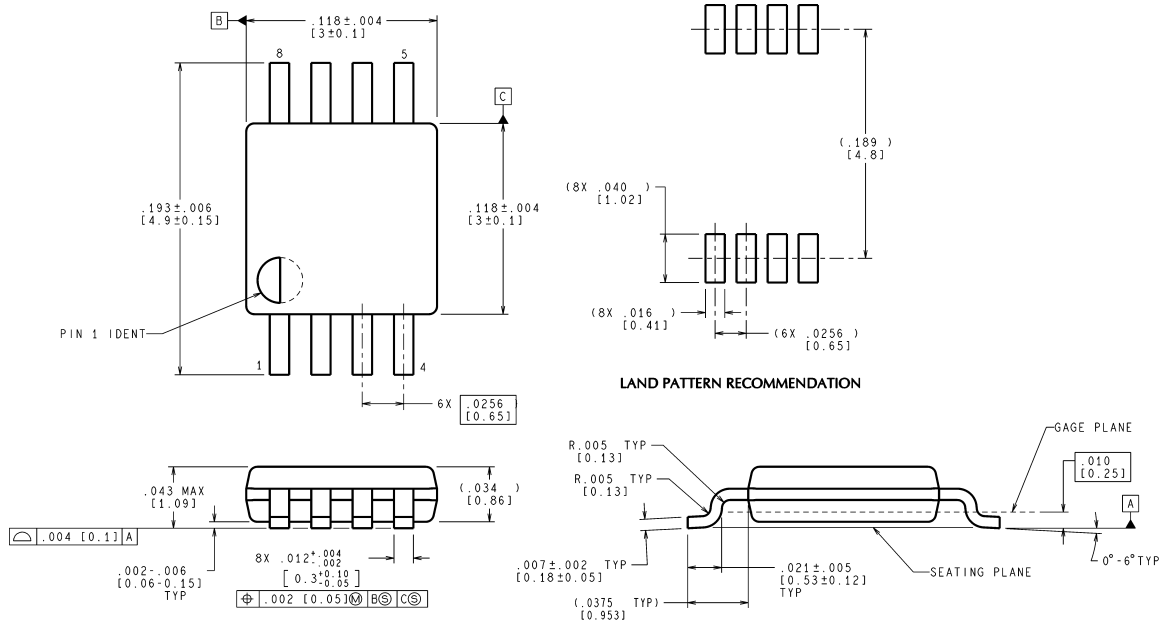

MUA08A (Rev E)

**8-Lead Mini SOIC package (MM)
NS Package Number MUA08A**

National does not assume any responsibility for use of any circuitry described, no circuit patent licenses are implied and National reserves the right at any time without notice to change said circuitry and specifications.

For the most current product information visit us at www.national.com.

LIFE SUPPORT POLICY

NATIONAL'S PRODUCTS ARE NOT AUTHORIZED FOR USE AS CRITICAL COMPONENTS IN LIFE SUPPORT DEVICES OR SYSTEMS WITHOUT THE EXPRESS WRITTEN APPROVAL OF THE PRESIDENT AND GENERAL COUNSEL OF NATIONAL SEMICONDUCTOR CORPORATION. As used herein:

1. Life support devices or systems are devices or systems which, (a) are intended for surgical implant into the body, or (b) support or sustain life, and whose failure to perform when properly used in accordance with instructions for use provided in the labeling, can be reasonably expected to result in a significant injury to the user.
2. A critical component is any component of a life support device or system whose failure to perform can be reasonably expected to cause the failure of the life support device or system, or to affect its safety or effectiveness.

BANNED SUBSTANCE COMPLIANCE

National Semiconductor follows the provisions of the Product Stewardship Guide for Customers (CSP-9-111C2) and Banned Substances and Materials of Interest Specification (CSP-9-111S2) for regulatory environmental compliance. Details may be found at: www.national.com/quality/green.

Lead free products are RoHS compliant.



National Semiconductor
Americas Customer
Support Center
Email: new.feedback@nsc.com
Tel: 1-800-272-9959

National Semiconductor
Europe Customer Support Center
Fax: +49 (0) 180-530 85 86
Email: europe.support@nsc.com
Deutsch Tel: +49 (0) 69 9508 6208
English Tel: +44 (0) 870 24 0 2171
Français Tel: +33 (0) 1 41 91 8790

National Semiconductor
Asia Pacific Customer
Support Center
Email: ap.support@nsc.com

National Semiconductor
Japan Customer Support Center
Fax: 81-3-5639-7507
Email: jpn.feedback@nsc.com
Tel: 81-3-5639-7560